

The table below shows the standard program of stainless steel gas springs available, non - standard sizes are available on special order.

The diagram also shows hatch size indication when mounting the gas spring in the rim of the hatch, with 90 degree opening. For other applications use the formula below or contact our office.

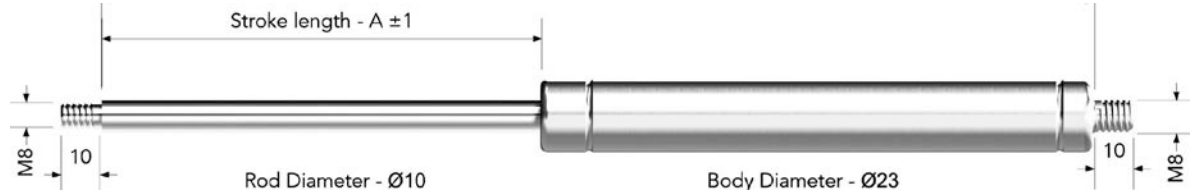

Stainless steel Gas spring I.D.#	Hatch weight lb. for 1 spring	Hatch in inches Max. size	Force IN Newton	Stroke length		Rod diameter	Cylinder diameter	Overall length, extended and compressed, not counting the threads, without attachments		Thread on both sides
				mm	inches			mm	inch	
6-15-50	4 / 30lb	8"	25 / 400 N	50	2"	6 mm	15 mm	130 / 80	5 1/8" / 3 1/8"	M 5 x 0.8
6-15-65	4 / 30lb	10"	25 / 400 N	65	2 3/8"	6 mm	15 mm	160 / 95	6 1/4" / 3 3/4"	M 5 x 0.8
6-15-80	4 / 30lb	12 1/2"	25 / 400 N	80	3"	6 mm	15 mm	190 / 110	8 1/4" / 5 1/8"	M 5 x 0.8
6-15-100	4 / 30lb	15 3/4"	25 / 400 N	100	4"	6 mm	15 mm	230 / 130	9 1/16" / 5 1/8"	M 5 x 0.8
6-15-120	4 / 30lb	19 1/2"	25 / 400 N	120	4 3/4"	6 mm	15 mm	270 / 150	10 5/8" / 5 7/8"	M 5 x 0.8
6-15-150	4 / 30lb	23 1/2"	25 / 300 N	150	5 7/8"	6 mm	15 mm	330 / 180	13" / 7 1/16"	M 5 x 0.8
6-15-200	4 / 30lb	31 1/4"	25 / 300 N	200	7 7/8"	6 mm	15 mm	430 / 230	16 15/16" / 9 1/16"	M 5 x 0.8
8-18-100	10/70lb	15 3/4"	100 / 750 N	100	4"	8 mm	19 mm	245 / 145	9 5/8" / 5 3/4"	M 8 x 1.25
8-18-150	10/70lb	23 1/2"	100 / 750 N	150	5 7/8"	8 mm	19 mm	345 / 195	13 3/4" / 7 3/4"	M 8 x 1.25
8-18-200	10/70lb	31 1/4"	100 / 700 N	200	7 7/8"	8 mm	19 mm	445 / 245	17 1/2" / 9 5/8"	M 8 x 1.25
8-18-250	10/70lb	39 3/8"	100 / 700 N	250	9 7/8"	8 mm	19 mm	545 / 295	21 1/2" / 11 5/8"	M 8 x 1.25
10-23-100	15/120lb	15 3/4"	150 /1200 N	100	4"	10 mm	23 mm	245 / 145	9 5/8" / 5 3/4"	M 8 x 1.25
10-23-150	15/120lb	23 1/2"	150 /1200 N	150	5 7/8"	10 mm	23 mm	345 / 195	13 3/4" / 7 3/4"	M 8 x 1.25
10-23-200	15/120lb	31 1/4"	150 /1200 N	200	7 7/8"	10 mm	23 mm	445 / 245	17 1/2" / 9 5/8"	M 8 x 1.25
10-23-250*	15/110lb	39 3/8"	150 /1100 N	250	9 7/8"	10 mm	23 mm	545 / 295	21 1/2" / 11 5/8"	M 8 x 1.25
10-23-300*	15/100lb	47 1/4"	150 /900 N	300	11 13/16"	10 mm	23 mm	645 / 345	25 5/8" / 13 3/4"	M 8 x 1.25
10-23-350*	15/77lb	55 1/8"	150 /700 N	350	13 3/4"	10 mm	23 mm	745 / 395	29 5/16" / 15 9/16"	M 8 x 1.25
10-23-400*	15/65lb	63"	150 /500 N	400	15 3/4"	10 mm	23 mm	845 / 445	33 1/4" / 17 1/2"	M 8 x 1.25
*10-23-series	120 lb:	with	protection	tube	1200N					
14-28-100 / 14-28-500	25/250lb	15 3/4" 63"	250 /2500 N	100 / 500	4 / 19 11/16"	14 mm	28 mm	on request	on request	M 10 x 1.5
22-38-200 22-38-1000	50/500lb	15 3/4" 63"	500 / 5000 N		7 7/8 to 39 3/8"	22 mm	38 mm	on request	on request	M 14 x 1.5
30-65-1000	--/1650lb --/2200lb	15 3/4" to 63"	5000N / 10000N	1000 1000	39 3/8"			on request	on request	M 24 x 3

Compression Gas Springs Details per size: Please see page 6-5 to 6-10. For attachments: Please see page 6-11, 6-14 and 6-15.
For Blocking Gas Springs: Please see Page 6-10

HOW TO CHOOSE THE RIGHT GAS SPRING WITH THE RIGHT CHARGE:

Please find the following data:

1. The weight of the part (hatch) to be lifted.
2. The length of the hatch. This is the distance from the hinges to the locking side.
3. The thickness of the hatch. (small hatches which are very thick – like freezer hatches- need longer size gas springs)
4. The degree to which the hatch will be opened. (90 degrees or more, up to 160 degrees)

To find the actual weight of an existing hatch, without removing it from the deck, place a hanging scale on the side of the hatch in a position as close as possible to the horizontal position and multiply the measured weight by 2. Keep in account the friction of the hinges, if any, and the weight of locks and hatch dogging devises that can upset the center of gravity of the hatch. Adjust for these variables in the formula. See also pages 6-0-2-0 and 6-0-2-1.

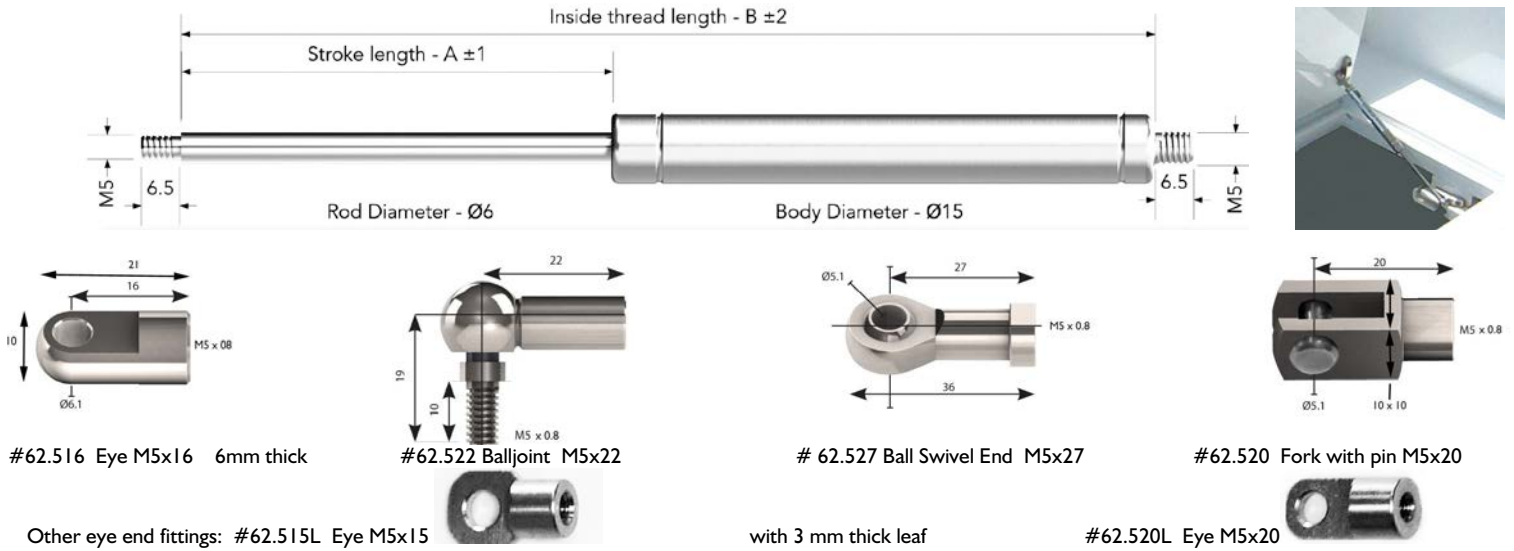
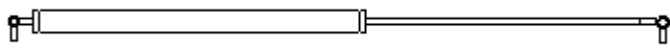

Part ID	6-15	A	B	#62.516	#62.522	#62.520	#62.527	Gas spring
	Series 6-15 stainless steel gas spring with valve	Stroke Length In mm	Total length without attachments (not counting the thread) 2 x stroke +30 mm	Eyes, add 2 x 16 mm	Ball joints, add 2 x 22 mm	Forks, add 2 x 20 mm	Swivel rod ends, add 2 x 27 mm	Thread size and max. N force per length rod
6-15-50	Extended	50 mm	130 mm	162 mm	174 mm	170 mm	178 mm	M5 x 08 - 400N max.
6-15-50	Compressed	50 mm	80 mm	112 mm	124 mm	120 mm	134 mm	M5 x 08 - 400N max.
6-15-65	Extended	65 mm	160 mm	192 mm	204 mm	200 mm	214 mm	M5 x 08 - 400N max.
6-15-65	Compressed	65 mm	95 mm	127 mm	139 mm	135 mm	149 mm	M5 x 08 - 400N max.
6-15-80	Extended	80 mm	190 mm	222 mm	234 mm	230 mm	244 mm	M5 x 08 - 400N max.
6-15-80	Compressed	80 mm	110 mm	142 mm	154 mm	150 mm	164 mm	M5 x 08 - 400N max.
6-15-100	Extended	100mm	230mm	262 mm	274 mm	270 mm	284 mm	M5 x 08 - 400N max.
6-15-100	Compressed	100 mm	130 mm	162 mm	174 mm	170 mm	184 mm	M5 x 08 - 400N max.
6-15-120	Extended	120mm	270 mm	302 mm	314 mm	310 mm	324 mm	M5 x 08 - 400N max.
6-15-120	Compressed	120 mm	150 mm	177 mm	189 mm	185 mm	199 mm	M5 x 08 - 400N max.
6-15-150	Extended	150 mm	330 mm	362 mm	374 mm	370 mm	384 mm	M5 x 08 - 300N max.
6-15-150	Compressed	150 mm	180 mm	212 mm	224 mm	220 mm	234 mm	M5 x 08 - 300N max.
6-15-200	Extended	200 mm	430 mm	462 mm	474 mm	470 mm	484 mm	M5 x 08 - 300N max.
6-15-200	Compressed	200 mm	230 mm	262 mm	274 mm	270 mm	284 mm	M5 x 08 - 300N max.

Maximum force in Newtons* 400N* (88 lb.)* Check also pages 6-0-2-0 and 6-0-2-1 for force calculation
 *Depends on rod length

Minimum charge in Newtons 25N (5.5 lb.) *For custom sizes please call office.

Application: "A" Gas spring Series: 6-15: Samples, indicating possible setups:

size 3: length of hatch	gas spring ID	weight hatch up to:	size 1: hatch bracket to hinge pin	size 2: coaming bracket to hinge pin with balljoints installed
400 mm ~ 16"	6-15-100 mm	33 lbs	75 mm ~ 3"	260 ~ 10 ¼"
600 mm ~ 23 ½"	6-15-150 mm	33 lbs	125 mm ~ 5"	362 mm ~ 14 1/8"
800 mm ~ 31 ½"	6-15-200 mm	33 lbs	175 mm ~ 6 7/8"	463 mm ~ 18 1/4"

Application: "B" Gas spring Series: 6-15: Samples, indicating possible setups:

size 3: length of hatch	gas spring ID	weight hatch up to:	size 1: hatch bracket to hinge pin	size 2: coaming bracket to hinge pin with ball joint
400 mm ~ 16"	6-15-150 mm	33 lbs	125 mm ~ 5"	376 mm ~ 14 ¾"
400 mm ~ 16"	6-15-200 mm	33 lbs	175 mm ~ 6 7/8"	500 mm ~ 19 ½"

ALWAYS INSTALL GAS SPRING WITH ROD DOWN AND CYLINDER UP

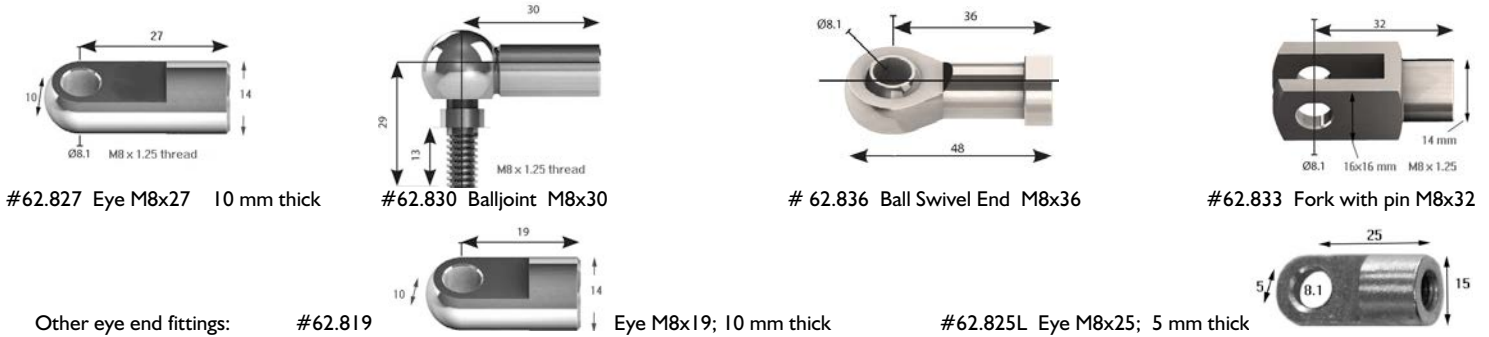
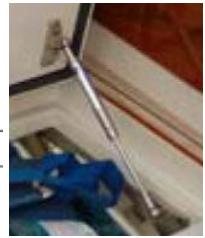
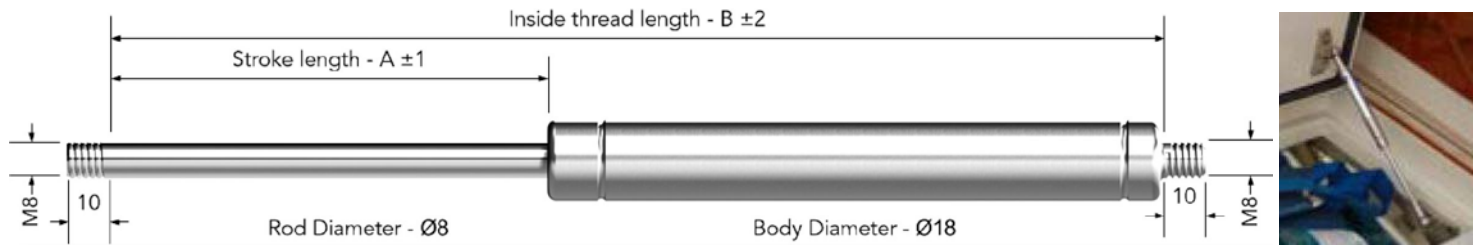
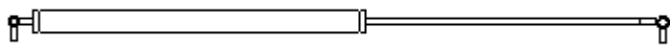

Part ID	8-18 Series 8-18-stainless steel gas spring with valve	A Stroke Length in mm	B Total length without attachments (not counting the thread) 2 x stroke+ 45 mm)	62.819 Short eyes, add 2 x 19 mm	62.827 big eyes, add 2 x 27 mm	62.830 Ball joints, add 2 x 30 mm	62.833 Forks Add 2 x 32 mm	Thread size and max. N force per length rod
8-18-100	Extended	100mm	245 mm	283 mm	299 mm	305 mm	310 mm	M8 x 1.25 - 750N
	Compressed	100 mm	145 mm	183 mm	199 mm	205 mm	210 mm	M8 x 1.25 - 750N
8-18-150	Extended	150 mm	345 mm	383 mm	399 mm	405 mm	410 mm	M8 x 1.25 - 750N
	Compressed	150 mm	195 mm	233 mm	249 mm	255 mm	260 mm	M8 x 1.25 - 750N
8-18-200	Extended	200 mm	445 mm	483 mm	499 mm	505 mm	510 mm	M8 x 1.25 - 700N
	Compressed	200 mm	245 mm	283 mm	299 mm	305 mm	310 mm	M8 x 1.25 - 700N
8-18-250	Extended	250 mm	545 mm	583 mm	599 mm	605 mm	610 mm	M8 x 1.25 - 700N
	Compressed	250 mm	295 mm	333 mm	349 mm	355 mm	360 mm	M8 x 1.25 - 700N

Maximum force in Newtons* 750N* (165 lb.)* Check also pages 6-0-2-0 and 6-0-2-1 for force calculation
 *Depends on rod length
 Minimum charge in Newtons 100N (22 lb.) *For custom sizes please call office.

Application: "A" Gas spring Series: 8-18:

size 3: length of hatch	gas spring ID	weight hatch up to:	size 1: hatch bracket to hinge pin	size 2: coaming bracket to hinge pin with balljoints installed
400 mm ~ 16"	8-19-100 mm	77 lbs	75 mm ~ 3"	280 ~ 11"
600 mm ~ 23 1/2"	8-19-150 mm	77 lbs	125 mm ~ 5"	396 mm ~ 15 1/2"
800 mm ~ 31 1/2"	8-19-200 mm	77 lbs	175 mm ~ 6 7/8"	495 mm ~ 19 1/2"
1000 mm ~ 39 1/2"	8-19-250 mm	77 lbs	225 mm ~ 8 7/8"	595 mm ~ 23 1/2"

Application: "B" Gas spring Series: 8-18:

size 3: length of hatch	gas spring ID	weight hatch up to:	size 1: hatch bracket to hinge pin	size 2: coaming bracket to hinge pin with ball joint
400 mm ~ 16"	8-19-150 mm	77 lbs	125 mm ~ 5"	405 mm ~ 16"
600 mm ~ 23 1/2"	8-19-200 mm	77 lbs	175 mm ~ 6 7/8"	500 mm ~ 19 1/2"
800 mm ~ 31 1/2"	8-19-250 mm	77 lbs	225 mm ~ 8 7/8"	610 mm ~ 24"

Application: "C" Gas spring Series: 8-18:

size 3: length of hatch	gas spring ID	weight hatch up to:	size 1: angle 45° distance bracket to hinge pin	size 2: check distance in open and closed position before mounting
400 mm ~ 16"	8-19-100 mm	77 lbs	68 mm ~ 2 3/4"	Our office provides custom applications upon request.
600 mm ~ 23 1/2"	8-19-150 mm	77 lbs	106 mm ~ 4 1/8"	
800 mm ~ 31 1/2"	8-19-200 mm	77 lbs	141 mm ~ 5 1/2"	
1000 mm ~ 39 1/2"	8-19-250 mm	77 lbs	177 mm ~ 7"	

ALWAYS INSTALL GAS SPRING WITH ROD DOWN AND CYLINDER UP

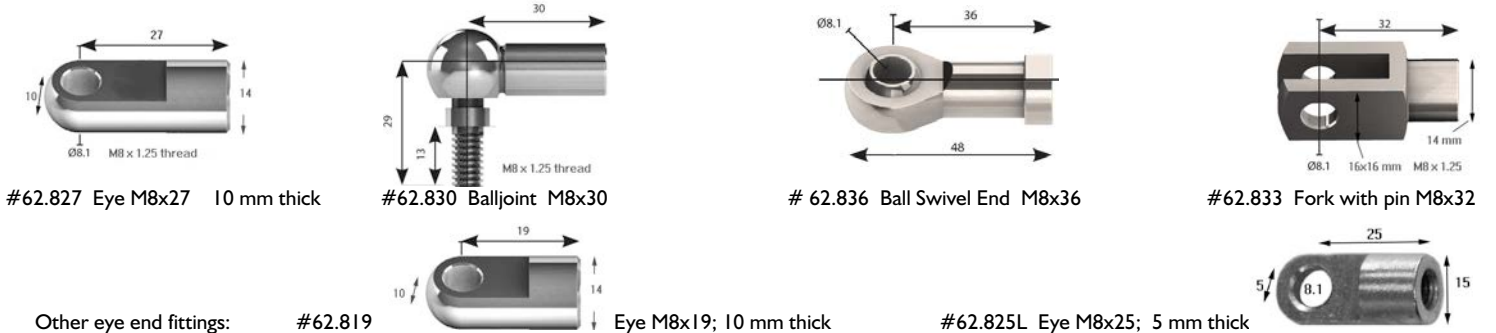
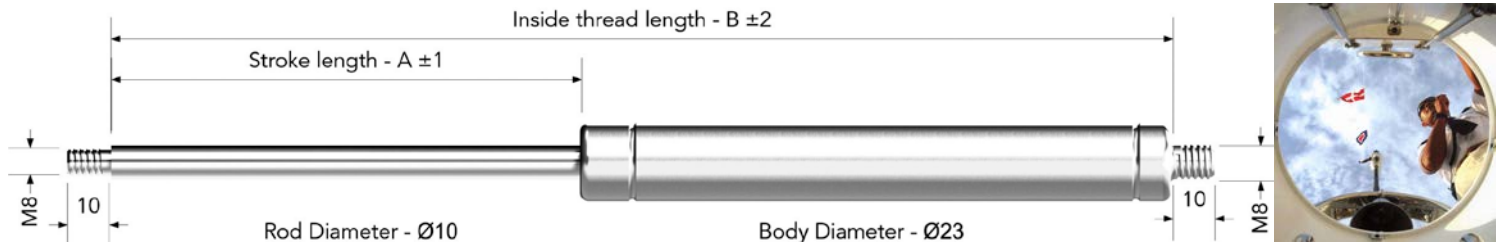
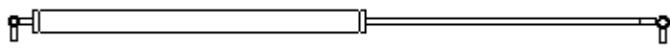

Part ID	10-23 Series 10-23-stainless steel gas spring with valve	A Stroke Length in mm	B Total length without attachments (not counting the thread) 2 x stroke+ 45 mm)	62.819 Short eyes, add 2 x 19 mm	62.827 big eyes, add 2 x 27 mm	62.830 Ball joints, add 2 x 30 mm	62.833 Forks Add 2 x 32 mm	Thread size and max. N force per rod length
10-23-100	Extended	100mm	245 mm	283 mm	299 mm	305 mm	309 mm	M8 x 1.25 – 1250N
	Compressed	100 mm	145 mm	183 mm	199 mm	205 mm	209 mm	M8 x 1.25 – 1250N
10-23-150	Extended	150 mm	345 mm	383 mm	399 mm	405 mm	409 mm	M8 x 1.25 – 1250N
	Compressed	150 mm	195 mm	233 mm	249 mm	255 mm	259 mm	M8 x 1.25 – 1250N
10-23-200	Extended	200 mm	445 mm	483 mm	499 mm	505 mm	509 mm	M8 x 1.25 - 1250N
	Compressed	200 mm	245 mm	283 mm	299 mm	305 mm	309 mm	M8 x 1.25 – 1250N
10-23-250	Extended	250 mm	545 mm	583 mm	599 mm	605 mm	609 mm	M8 x 1.25 – 1100N*
	Compressed	250 mm	295 mm	333 mm	349 mm	355 mm	359 mm	M8 x 1.25 – 1100N*
10-23-300	Extended	300 mm	645 mm	683 mm	699 mm	705 mm	709 mm	M8 x 1.25 – 900N*
	Compressed	300 mm	345 mm	383 mm	399 mm	405 mm	409 mm	M8 x 1.25 – 900N*
10-23-350	Extended	350 mm	745 mm	683 mm	799 mm	805 mm	809 mm	M8 x 1.25 – 700N*
	Compressed	350 mm	395 mm	433 mm	449 mm	455 mm	459 mm	M8 x 1.25 – 700N*
10-23-400	Extended	400 mm	845 mm	883 mm	899 mm	905 mm	909 mm	M8 x 1.25 – 500N*
	Compressed	400 mm	445 mm	483 mm	499 mm	505 mm	509 mm	M8 x 1.25 – 500N*
10-23-400	W. PROTECTION TUBE	400 mm	848 mm	886 mm	902 mm	908 mm	912 mm	M8 x 1.25 – 1200N*

*10-23 Series gas spring are supplied with protection tube when force is above nominal set force



Maximum force depends on rod length	1250N* (275 lb.)*	Check also pages 6-0-2-0 and 6-0-2-1 for force calculation
Minimum charge in Newtons	100N (22 lb.)	*For custom sizes please call office.



10-23 Series Gas Spring with Protection Tube

10-23 Series Gas Spring with Protection Tubes.

Protection tubes offer higher bending resistance and protection against dust, dirt and scratching.

If 10-23 series gas springs are ordered with above nominal force (see table above for max allowed nominal force) a protection tube is supplied.

Maximum force with protection tube: 1200N (264lb.)

Add 3 mm to the overall length with protection tube

size 3:	gas spring ID	weight hatch up to:	size 1:	size 2:
length of hatch:			hatch bracket to hinge pin:	Coaming bracket to hinge pin with balljoints installed:
600 mm ~ 23 1/2"	10-23-150 mm	132 lbs	125 mm ~ 5"	396 mm ~ 15 1/2"
800 mm ~ 31 1/2"	10-23-200 mm	132 lbs	175 mm ~ 6 7/8"	495 mm ~ 19 1/2"
1000mm ~ 39 1/2"	10-23-250 mm	132 lbs	225 mm ~ 8 7/8"	595 mm ~ 23 1/2"
1200 mm ~ 47 1/4"	10-23-300 mm	132 lbs	270 mm ~ 10 1/2"	690 mm ~ 27 1/8"
1400 mm ~ 55"	10-23-350 mm	132 lbs	320 mm ~ 12 1/2"	790 mm ~ 31"
1600 mm ~ 63"	10-23-400 mm	132 lbs	365 mm ~ 14 3/4"	885 mm ~ 34 3/4"

ALWAYS INSTALL GAS SPRING WITH ROD DOWN AND CYLINDER UP

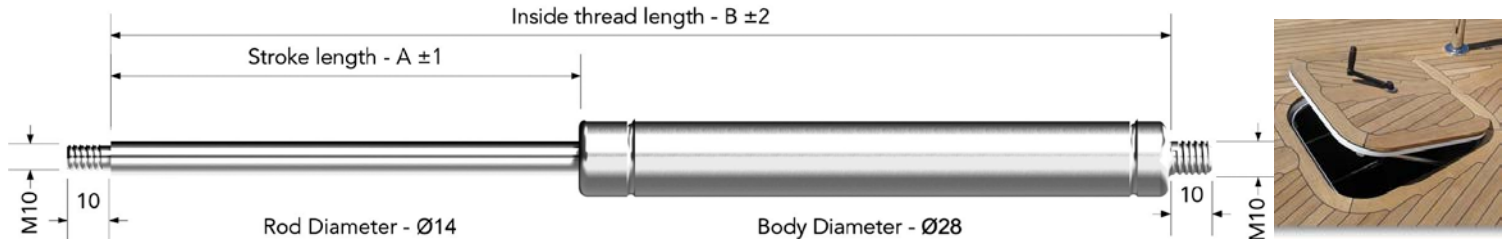
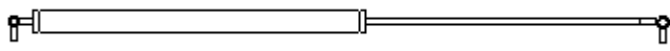

Part ID	14-28 Series 14-28-stainless steel gas spring with valve	A Stroke Length in mm	B Total length without attachments (not counting the thread) 2 x stroke+ 50 mm)	62.123L Short Eyes, add 2 x 23 mm	62.127 Long Eyes, add 2 x 27 mm	62.135 Ball Joints, add 2 x 35 mm	62.140 Forks Add 2 x 40 mm	Thread size and max. N force per rod length*
14-28-100	Extended	100mm	250 mm	296 mm	304 mm	320 mm	330 mm	M10 – 2500N
	Compressed	100 mm	150 mm	196 mm	204 mm	220 mm	230 mm	M10 – 2500N
14-28-150	Extended	150 mm	350 mm	396 mm	404 mm	420 mm	430 mm	M10 – 2500N
	Compressed	150 mm	200 mm	246 mm	254 mm	270 mm	280 mm	M10 – 2500N
14-28-200	Extended	200 mm	450 mm	496 mm	504 mm	520 mm	530 mm	M10 – 2500N
	Compressed	200 mm	250 mm	296 mm	304 mm	320 mm	330 mm	M10 – 2500N
14-28-250	Extended	250 mm	550 mm	596 mm	604 mm	620 mm	630 mm	M10 – 2500N
	Compressed	250 mm	300 mm	346 mm	354 mm	370 mm	380 mm	M10 – 2500N
14-28-300	Extended	300 mm	650 mm	696 mm	704 mm	720 mm	730 mm	M10 – 2500N
	Compressed	300 mm	350 mm	396 mm	404 mm	420 mm	430 mm	M10 – 2500N
14-28-350	Extended	350 mm	750 mm	796 mm	804 mm	820 mm	830 mm	M10 – 2500N
	Compressed	350 mm	400 mm	446 mm	454 mm	470 mm	480 mm	M10 – 2500N
14-28-400	Extended	400 mm	850 mm	896 mm	904 mm	920 mm	930 mm	M10 – 1900N*
	Compressed	400 mm	450 mm	496 mm	504 mm	520 mm	530 mm	M10 – 1900N*
14-28-500	Extended	500 mm	1050 mm	1096 mm	1104 mm	1120 mm	1130 mm	M10 – 1500N*
	Compressed	500 mm	550 mm	596 mm	604 mm	620 mm	630 mm	M10 – 1500N*

Maximum force depends on rod length 2500N (550 lb.)* Check also pages 6-0-2-0 and 6-0-2-1 for force calculations
 Minimum charge in Newtons 250N (55 lb.) Please contact our office for Custom sizes



14-28 Series Gas Spring with Protection Tube

***14-28 Series Gas Spring with Protection Tubes.** Protection tubes offer higher bending resistance and protection against dust, dirt and scratching.

*14-28 series gas springs with protecting tubes are not a stocking item. Special order only. Add 10 mm to the overall length of the gas spring when ordered with protection tube. To order by Email: Sales@Izerwaren.com

ALWAYS INSTALL GAS SPRING WITH ROD DOWN AND CYLINDER UP

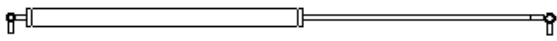

Gas springs with Locking Sleeve - featuring 14-28 series stainless steel gas springs

For applications that require extra safety by locking the hatch in an open position.

To close the hatch, release sleeve by depressing it. Hatch may have to be slightly lifted to allow for release the sleeve

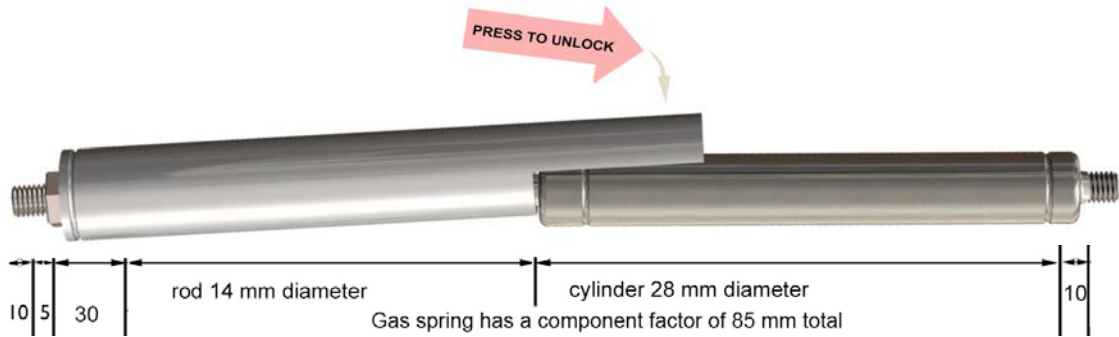

The offset mounted threaded rod attached on a ball swivel allows the sleeve to be pushed to one side and automatically lock in open position.

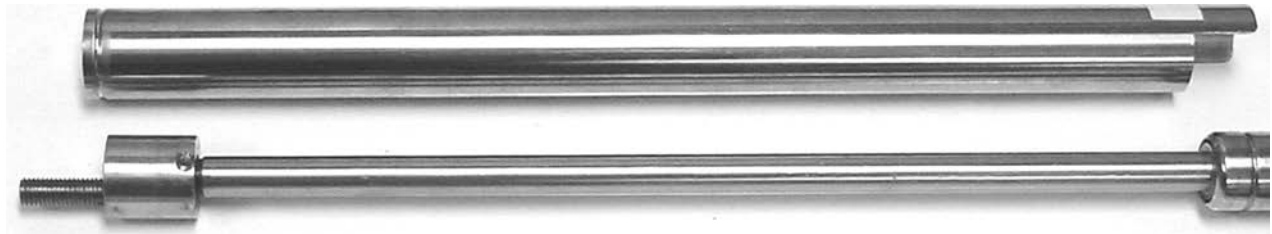

Showing all parts separate. Locking tube; Rod with ball end; Swivel with treaded rod



#62.127 Eye M10x27



#62.123L M10x23



#62.135 Ball Joint M10x35

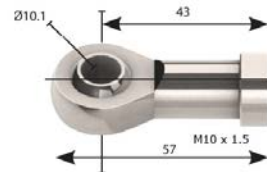

62.443 Ball Swivel End M10x43



#62.140 Fork M10x43

Part ID	14-28 Locking	Stroke	Total length without	62.127	62.443	62.140	Thread size
Order #	Stainless steel	Length in	attachments	Eyes,	Ball Joints,	Forks,	And Newton
Series	gas spring	mm	(not counting the thread)	Add	add	add	Force
14-28 Lock	with valve		(x stroke + 85 mm)	2 x 27 mm	2 x 35 mm	2 x 40 mm	
14-28-350L	Extended	350 mm	785 mm	839 mm	855 mm	865 mm	M10 x 1.5 – 1000N*
	Compressed	350 mm	435 mm	489 mm	505 mm	515 mm	M10 x 1.5 – 1000N*
	Maximum charge in Newton force		1000N (220lb.)				
	Minimum Charge in Newton force		250N (55 lb.)				

***Max force for one locking gas spring 14-28 series is 220 lbs or 1000 Newton.**

The maximum hatch weight is 110 lbs. when using one gas spring with locking sleeve

The maximum hatch weight is 220 lbs. when using two gas springs

We recommend using one locking and one regular gas spring combination in one application

Please Note:

14-28 Series Gas Spring with Locking Sleeve are available in different stroke lengths.

All Locking Sleeve Gas Springs are custom made to order. The locking sleeve cannot be retrofitted onto a standard 14-28 gas spring.

Please allow minimum 4 weeks lead-time.

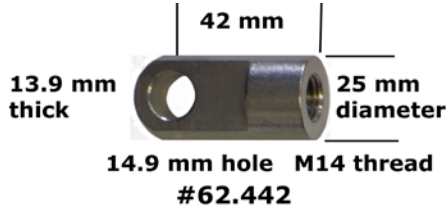
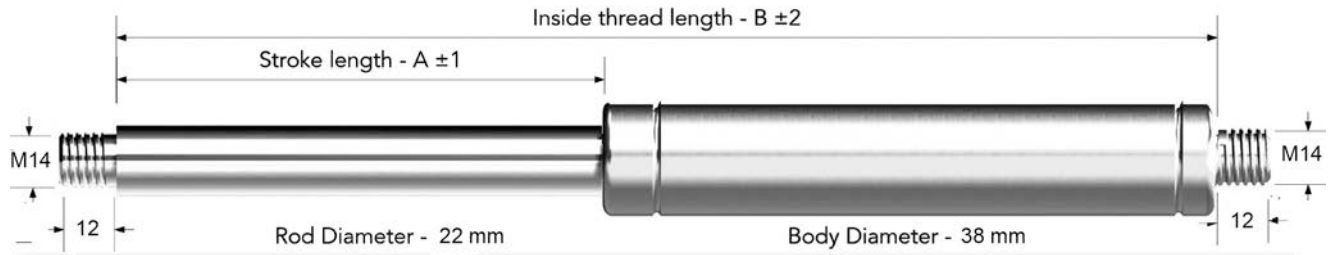
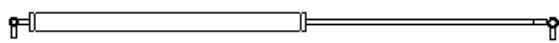

#62.442 Stainless steel eye M14 x 42 mm

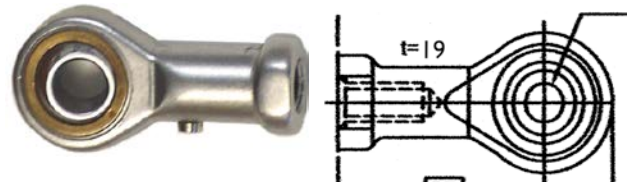

#62.457 Stainless steel swivel ends M14 x 76 mm

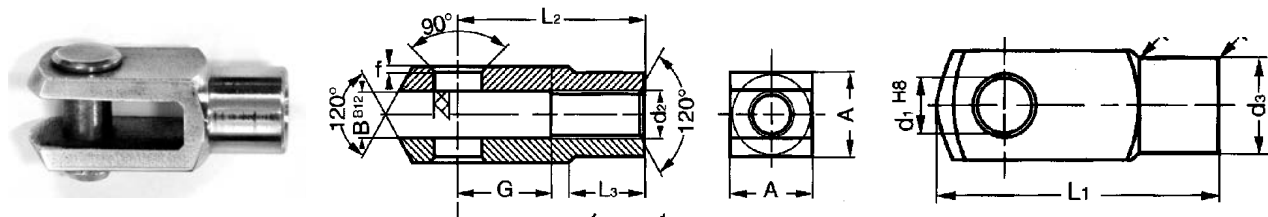

#62.456 Stainless Steel Fork with Pin. Pin can be removed from fork after removing circlip



Application: Two 22-38-400 gas springs, 2342 Newton force each with custom made brackets.

Series 14-28	22-38 Stainless steel gas spring with valve	A Stroke	B Total length without attachments; 2 x the stroke + 70 mm	#62.422 With Eyes, add 2 x 42 mm	#62.456 With Forks, add 2 x 56 mm	Thread size Maximum Newton Force*
22-38-200	Extended	200mm	470 mm	554 mm	582 mm	M14 x 1.5 – 5000N
	Compressed		270 mm	354 mm	382 mm	M14 x 1.5 – 5000N
22-38-400	Extended	400mm	870 mm	954 mm	982 mm	M14 x 1.5 – 4000N
(4000N MAX)	Compressed		470 mm	554 mm	582 mm	M14 x 1.5 – 4000N
22-38-500	Extended	500 mm	1070 mm	1154 mm	1382 mm	M14 x 1.5 – 3800N
(3800N MAX)	Compressed		570 mm	754 mm	782mm	M14 x 1.5 – 3800N
22-38-600	Extended	600 mm	1270 mm	1154 mm	1382 mm	M14 x 1.5 – 3500N
(3500N MAX)	Compressed		670 mm	754 mm	782mm	M14 x 1.5 – 3500N
22-38-800	Extended	800 mm	1670 mm	1754 mm	1782 mm	M14 x 1.5 – 2800N
(2800N MAX)	Compressed		870 mm	954 mm	982 mm	M14 x 1.5 – 2800N
22-38-1000	Extended	1000 mm	2070 mm	2154 mm	2182 mm	M14 x 1.5 – 2500N
(2500N MAX)	Compressed		1070 mm	1154 mm	1182 mm	M14 x 1.5 – 2500N
Maximum charge in Newton force			5000N (1100lb.)*	*Maximum Newton force rating depends on application and rod length		
Minimum Charge in Newton force			500N (110 lb.)	22-38 Series Gas Springs are special order only; lead-times apply.		

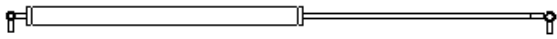

**Stainless steel gas springs with stainless steel hand operated blocking valve.
Allows the Gas spring to be stopped in any position by turning wheel.**



Blocking Gas Spring Set as complete assembly: #63.120 (Series 10-23-200) and #63.125 (Series 10-23-250)
Parts of set include: Gas spring; protection tube, blocking lever set. Please order endfittings separate.



Picture:

Blocking gas spring and standard gas spring installed side by side



Stainless steel knob lever set assembly for blocking gas springs

Operation: Turn knob lever from blocking position to not blocking position: 1/2 turn with click
Part number Blocking Knob Lever separate: #62.143

END FITTINGS:

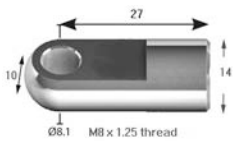

#62.827 Eye M8x27 ;10 mm thick

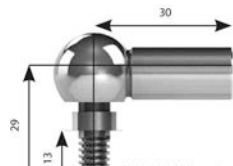

#62.830 Balljoint M8x30

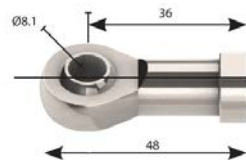

62.536 Ball Swivel End M8x36

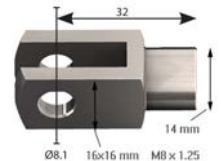

#62.833 Fork with pin M8x32

Other eye end fittings:



#62.819 Eye M8x19; end 10 mm thick

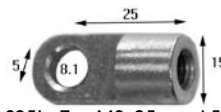

#62.825L Eye M8x25; end 5 mm thick

Series	Blocking Stainless steel gas spring with valve	Stroke	Total length without attachments (not counting the thread) 2 x stroke + 188.5 mm	62.819 Short Eyes: add 2 x 19 mm	62.827 Long Eyes: add 2 x 27 mm	62.830 Ball Joints: add 2 x 30 mm	Rod thread size	Cylinder Thread size Newton Force
10-23-200	Extended	200 mm	588.5 mm	626.5 mm	642.5 mm	648.5 mm	M10x1	M8x1.25 – 500N
	Compressed	200 mm	388.5 mm	426.5 mm	442.5 mm	448.5 mm	M10x1	M8x1.25 – 500N
10-23-250	Extended	250 mm	688.5 mm	726.5 mm	742.5 mm	748.5 mm	M10x1	M8x1.25 – 500N
	Compressed	250 mm	438.5 mm	476.5 mm	492.5 mm	498.5 mm	M10x1	M8x1.25 – 500N

Max / min. charge in Newton force 500N to 150N / 110lb. to 33 lb.

The use of a blocking gas springs allows hatches to be opened and locked in any position.

Maximum weight hatch using one blocking gas spring: 100 lbs./ 45 kg / 450 N

For applications using two gas springs, with one standard and with one blocking gas spring the maximum weight of the hatch is 300 lbs.

Please email Sales@Izerwaren.com for details.

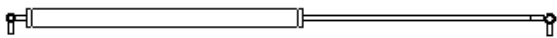

Stainless Steel Eyes M5 x 08

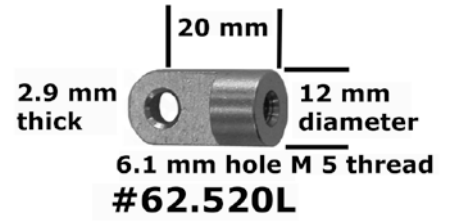

Stainless Steel Eyes M6 x 1

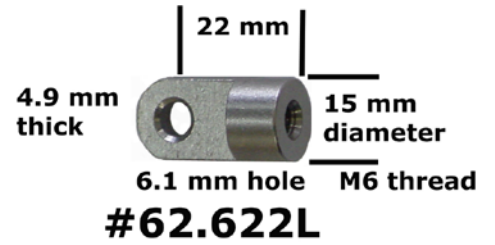
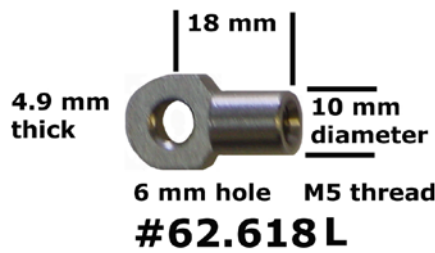

Stainless Steel Eyes M8 x 1.25



Stainless Steel Eyes M8 x 1.25

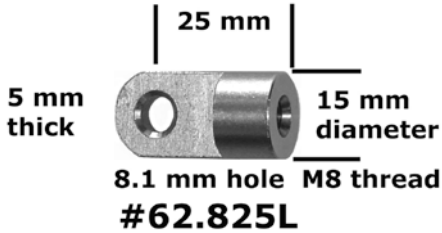

Stainless Steel Eyes M10 x 1.5

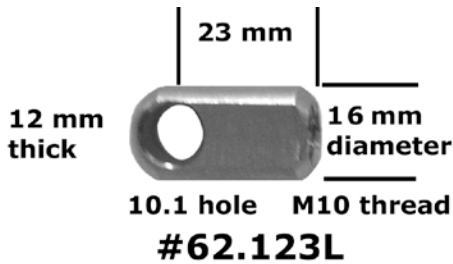

Stainless Steel Eyes M14 x 1.5

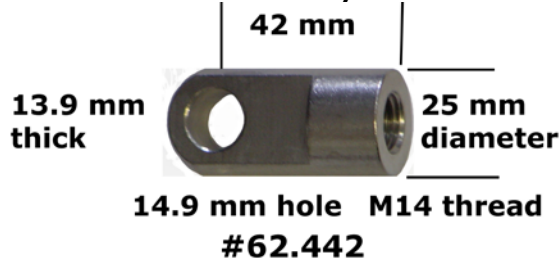

**Note: All Eye End Fittings are supplied in standard mill finish.
Eye end fittings with part numbers ending with "L" are made of 316 stainless steel.
Otherwise they are made of 304 stainless steel.**

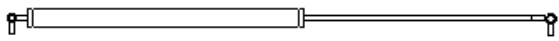

Stainless Steel Ball joints, swivel 18 degrees; ball can be separated from cup after removing circlip

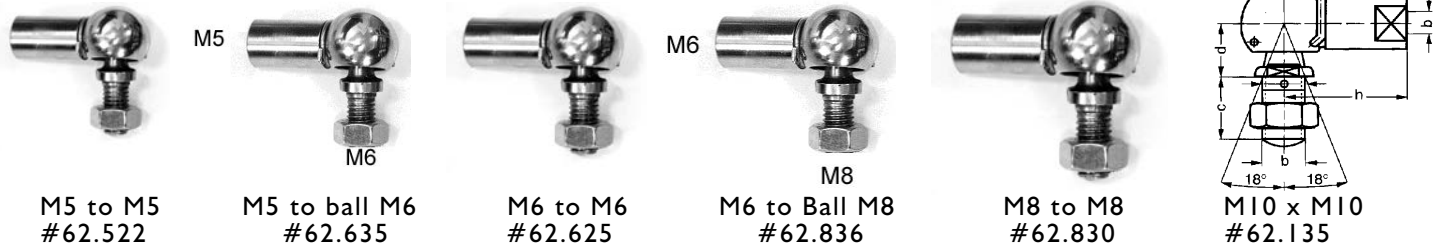

Ball joints Order numbers	OD diameter	For size hole	Overall length	Thread (b)	Distance To ball (h)	size ball	For gas spring series
62.522	10 mm	5.1 mm	28 mm	M5 x 0.8	22 mm	8 mm	6-15
62.635	10 mm	6.1 mm	28 mm	M5 x 0.8 M6 x 1	22 mm	8 mm	6-15
62.625	10 mm	5.1 mm	32 mm	M6 x 1	25 mm	10 mm	Not applicable
62.836	14 mm	8.1 mm	39 mm	M6 x 1 M8 x 1.25	30 mm	13 mm	Not applicable
62.830	14 mm	8.1 mm	39 mm	M8 x 1.25	30 mm	13 mm	8-19 and 10-23
62.135	18 mm	10.1 mm	47 mm	M10 x 1.5	35 mm	16 mm	14-28

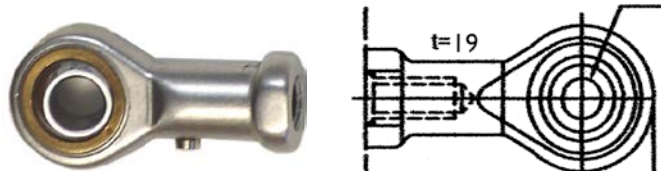

Stainless Steel Swivel Ball Ends. Swivels 12 degrees to either side

Swivel Ends Order numbers	OD diameter	size hole Ø	Overall length	Thread	Distance	For gas spring series
62.527	9 / 11 mm	5.1 mm	36 mm	M5 x 0.80	27 mm	6-15
62.536	12.5 / 16 mm	8.1 mm	48 mm	M8 x 1.25	36 mm	8-19 and 10-23
62.443	15 / 19 mm	10.1 mm	58 mm	M10x 1.5	43 mm	14-28
62.457	20 / 25 mm	14.1 mm	76 mm	M14 x 15	57 mm	22-38

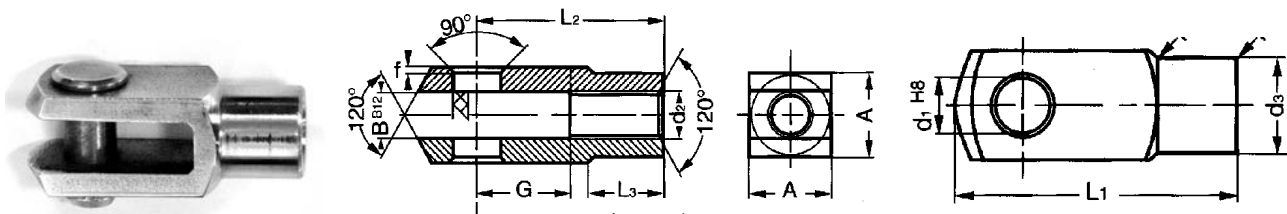

Stainless Steel Fork with Pin. Pin can be removed from fork after removing circlip

Forks with Pin Order number	D3 diameter	pin diameter	L1 Overall length	L2 Length to pin	A= square dimension	Circlip size	For gas spring series
62.520	9 mm	5 mm	26 mm	20 mm	10x10 mm	5	6-15
62.833	14 mm	8 mm	42 mm	33 mm	16x16 mm	8	8-19 and 10-23
62.140	18 mm	10 mm	52 mm	40 mm	20x20 mm	10	14-28
62.456	24 mm	14 mm	72 mm	56 mm	27x27 mm	14	22-38

Note: All parts listed above are available from stock.

Please see for other eye-endfittings page 6-11-A

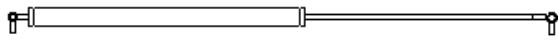

Izerwaren
order
numbers

- 64.088 Hatch mounting bracket for ball joints M8
- 64.089 Hatch mounting bracket for ball joints M10
Cast stainless steel
1 1/2" x 2 3/8" footprint; 3/4" stand off



#64.088 Hatch mounting bracket: 1 1/2" x 2 3/8" footprint 3/4" Ball joints to be ordered separately

#64.089 for M10



#64.741 Angle bracket

- 64.205 Hatch mounting bracket for Eyes M8
1 1/4" stand off
- 64.206 Hatch mounting bracket for Eyes M10
1 1/4" stand off



#64.205 Bracket for eyes using M8 or M10 eyes



When using M10 ball joints order: #64.206 ball joints and eyes sold separately

- 64.255 Bulkhead mounting bracket for ball joints M8
 - 64.256 Bulkhead mounting bracket for ball joints M10
 - 64.257 Bulkhead mounting bracket for eyes M8
 - 64.258 Bulkhead mounting bracket for eyes M10
- Cast stainless steel
1 7/8" x 2 7/8" footprint; 3/4" stand off

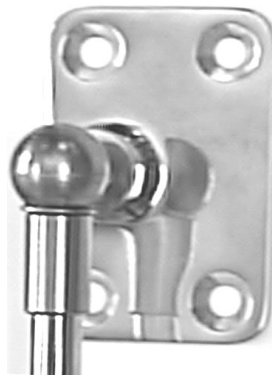

#64.255 Bulkhead mounting bracket using M8 ball joints



Cast stainless steel 1 7/8" x 2 7/8" footprint; 3/4" stand off ball joints and eyes sold separately



#64.257 Bulkhead mounting bracket using M8 eye

- 64.250 Bulkhead mounting bracket for ball joints M5
Cast stainless steel, polished
2" x 7/8" footprint
3/4" stand off



#64.250 Bulkhead mounting bracket 2" x 7/8" footprint 3/4" stand off



- 64.200 Hatch mounting bracket for ball joints M5
Cast stainless steel, polished
2 3/8" x 3/4" footprint
1 1/4" stand off



#64.200 Hatch mounting bracket M5 eye 2 3/8" x 3/4" footprint 1 1/4" stand off ball joints and eyes sold separately

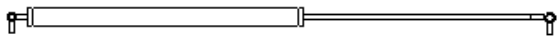

MEDIUM DUTY GAS SPRING BRACKETS 5/32" ~ 2.5 mm thick



#64.582H5
with hole M5



#64.582H8
with hole M8



#64.8825
Ball joint M8 outside



#64.5825B
Ball joint M5 outside



#64.5825A
Ball joint M5 inside

ANGLE BRACKET 90 degree H: 1 3/16". L x W: 2"x 1 1/2"
5/32" thick. 316 stainless steel.



#64.584H5
with hole M5



#64.584H8
with hole M8



#64.8845
with ball joint M8



#64.5845
with ball joint M5

OFFSET BRACKET W: 2" x H: 1 3/4". 3/16" offset
2.5 mm thick or 5/32" thick. 316 stainless steel.



#64.583H5
with hole M5



#64.583H8
with hole M8



#64.8835
with ball joint M8



#64.5835
with ball joint M5

FLUSH BRACKET
2" wide x 1 11/16" high. 5/32" thick. 316 stainless steel

More gas spring brackets on page 6-14 and page 6-15-1 and page 6-15-2.

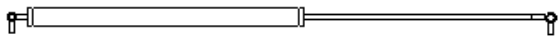

Part #

**MEDIUM DUTY GAS SPRING BRACKETS for Eyes M8
Small Footprint**

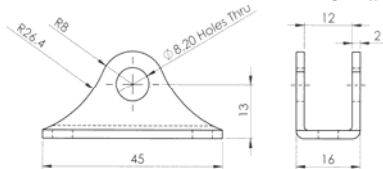

#64.306; U shaped 316 stainless steel bracket with pin for M8 eye end fittings. Shown with eye end fitting #62.819
Bracket size: 45 x 16 mm; mounting: 13 mm high. 1 3/4" x 5/8"; mounting: 1/2" high.

**MEDIUM DUTY GAS SPRING BRACKETS for Forks M8
Small Footprint**

64.306

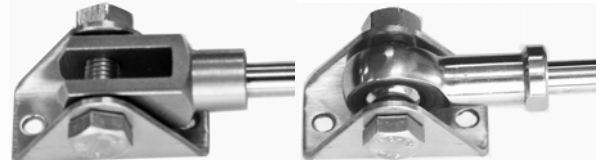
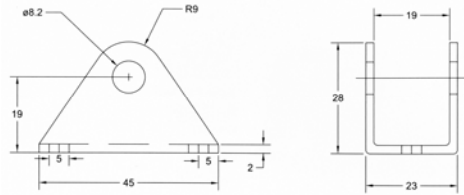

#64.303; U shaped 316 stainless steel bracket with bolt. Shown with M8 forks #62.833 and M8 swivel-end #62.538
Bracket size: 45 x 23 mm; mounting: 19 mm high. 1 3/4" x 15/16"; mounting: 3/4" high

HEAVY DUTY BRACKETS f

64.303

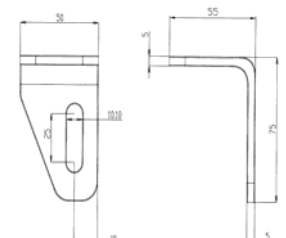
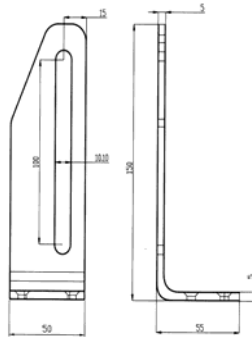

64.CLG #64.CLG; 150 x 50 mm; 55 mm high; 5 7/8" x 2"; 2 3/16" high.
64.CSM

#64.CSM 75 x 50 mm; 55 mm high. 3"x2"; 2 3/16" high.

Heavy duty brackets. Can also be used for Door Closer Gas Springs for Weather Doors.

65.D125

#65.D125 DOOR CLOSER GAS SPRING. HEAVY DUTY

For use on weather doors on yachts and ships with a weight up to 300 lbs.

- * Stainless steel Door closer gas spring #10-23-250-790
- * with stainless steel swivel eyes M 10
- * Stroke: 250 mm overall.
- * Length not counting threads, without end fittings: 700 mm
- * Center to Center distance end fitting: 790 mm
- * Please note stainless steel protection tube over rod.
- * This door closer has a controlled extension speed
- * Recommended Force setting: 500N
- * Force range: 150 to 500 Newton

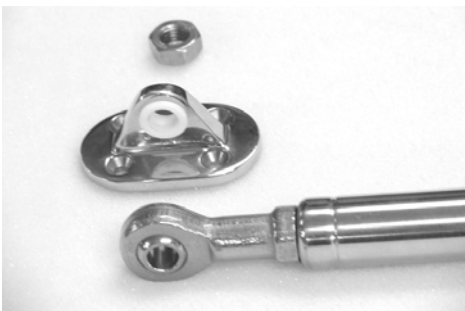
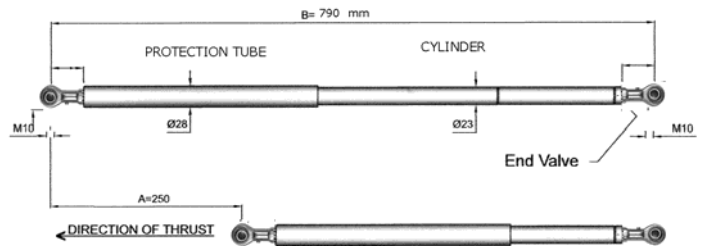

Set up with swivel ends #62.443 and #64.088 brackets

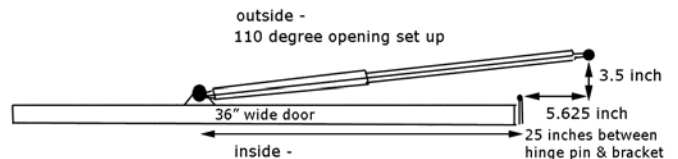

Possible set up of the 65.D125 door closer gas spring, using one bracket #62.443 and one bracket #64.CLG